

# RUSTY CHIMINEA





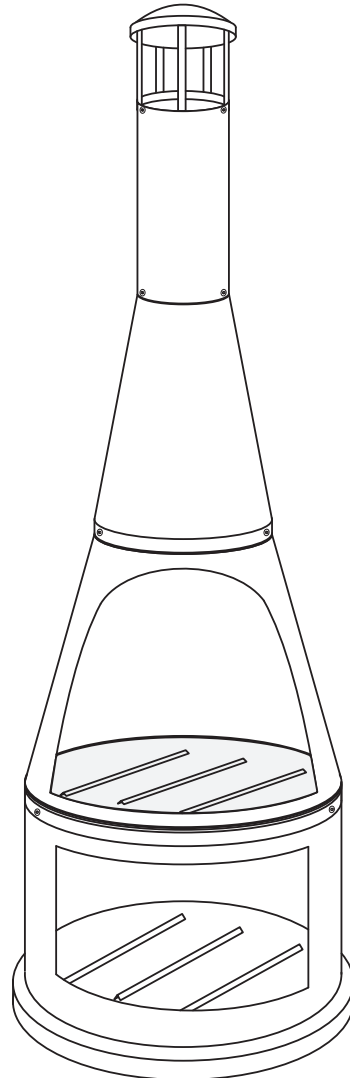

## SOV-3841

Review all assembly and care information before using this product. Save this manual for future reference.  
**Assemble components on a soft, clean surface to avoid damaging the finish.**

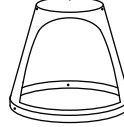

Inspect packaging to ensure all parts are accounted for before disposing of packing materials.

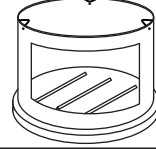

No.	PARTS	QTY.
A	 Flue Cap	1
B	 Flue	1
C	 Upper Body	1
D	 Lower Body	1
E	 Heat Plate	1
F	 Base	1
G	 Poker	1
H	 M6x10mm Bolt	12

INCLUDED TOOLS	
	Hex Key

**\*NOTE:** This fire pit is made from oxidized steel, the surface will naturally have a weathered, rusty finish. To help maintain its appearance and prevent further wear, cover the unit when not in use.

Use a drop cloth during assembly and avoid contact with clothing. The rusty finish may cause staining, especially when in contact with water.

### WARNING:

Manufacturer and seller expressly disclaim any and all liability from personal injury, property damage or loss, whether direct or indirect, or incidental, resulting from the incorrect attachment, improper use, inadequate maintenance, or neglect of this product.



### CAUTION:

Sharp edges.  
Wear gloves during assembly.



 **WARNING** 

**CHOKING HAZARD** — This item contains small parts that can be swallowed. Keep children and pets away during assembly.

# ASSEMBLY

Review all steps and understand assembly before beginning.

## STEP 1

F: 1  
E: 1

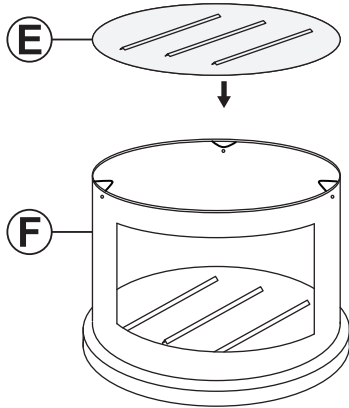

Place Heat Plate (E) onto Base (F).

## STEP 2

D: 1  
H: 3

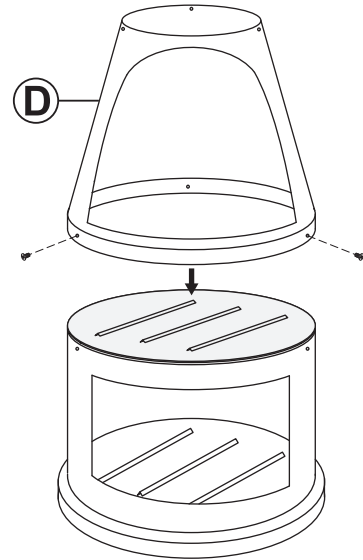

Secure Lower Body (D) to the base using three Bolts (H).

## STEP 3

C: 1  
H: 3

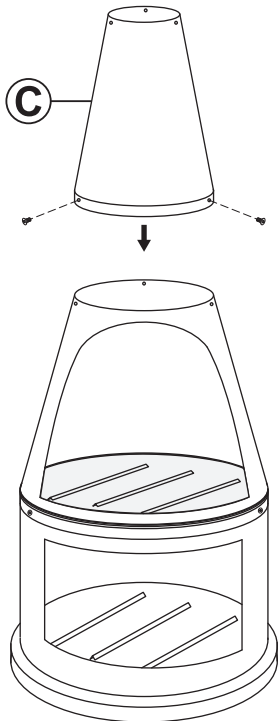

Secure Upper Body (C) to the lower body using three Bolts (H).

## STEP 4

B: 1  
H: 3

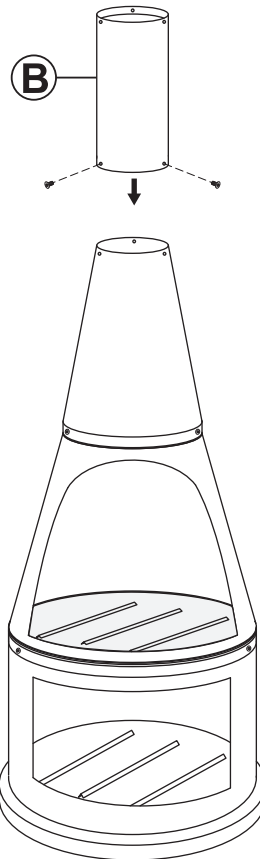

Secure Flue (B) to the upper body using three Bolts (H).

## STEP 5

A: 1  
H: 3

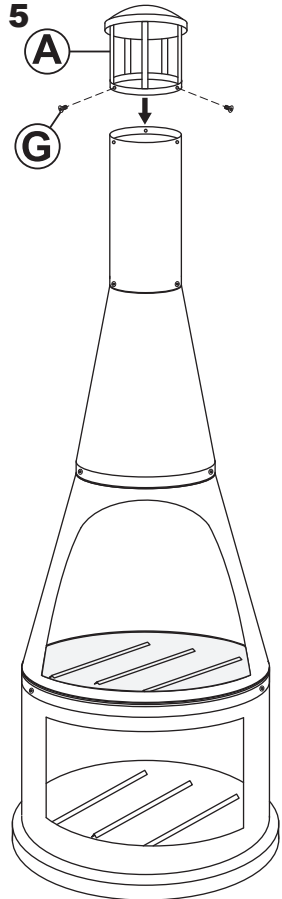

Secure Flue Cap (A) to the flue using three Bolts (H).

# CARE & MAINTENANCE

**SAFE USE:** Only use a fire pit on a flat, non-combustible surface such as concrete, rock, or stone. Do not use this unit on a wood deck or any other combustible surfaces like dry grass, leaves, mulch, etc. Never use in an area with an overhead structure or near any unprotected combustible constructions like vinyl or wood siding. Avoid using near or under overhanging trees and shrubs.

The unit will become extremely hot while in use. Always use heat-resistant gloves when maintaining a fire.

**NO ACCELERANTS, NO PLASTICS:** Never use an accelerant, i.e. gasoline or kerosene, to start a fire; doing so is dangerous and can damage your chiminea.

Never use any plastic materials in or near a fire pit. The emissions from burning plastic are toxic. Additionally, plastic residue is very difficult to remove.

**EXTINGUISH:** Let fire die down gradually and go out on its own. DO NOT use water to put out a fire as the sudden drop in temperature may cause serious injury and/or damage the metal.

**EXPOSURE & MAINTENANCE:** Exposure to humidity and/or outdoor weather elements will gradually affect the appearance and integrity of the unit. Help preserve the integrity and appearance of the unit by covering the unit when not in use.

Use a protective barrier to prevent damage and/or staining to surfaces such as, but not limited to, concrete patios and paved patios.

**CLEANING:** Remove ashes and debris before every use. Always ensure the unit and ashes are completely cool before cleaning. Ashes can remain hot long after a fire dies down. If you feel heat when your hand is close to the metal or the ashes, the unit is too hot to clean.

**COVER AND STORE:** Ensure the unit is completely cool and clean before covering (cover not included). Do not allow the unit to be exposed to water. Store in a dry location to protect it from environmental elements. The manufacturer is not liable for damage resulting from general use and/or environmental conditions.

**WARNING: THE ONE-YEAR WARRANTY DOES NOT COVER DAMAGES OR DEFECTS CAUSED BY THE APPLICATION OF CHEMICAL TREATMENTS, PROTECTIVE COATINGS, TOUCH-UP PAINT, OR CLEANING PRODUCTS.**

## SAFETY STATEMENTS & WARNINGS

- For outdoor use only. Never use this product in an enclosed area.
- Always follow local laws and regulations when using wood-burning fire pits.
- Exercise the same care and precautions as you would with an open fire.
- Always supervise children and pets when they are in proximity of this product, whether it is in use or not in use.
- Never use any fire pit during dry or windy conditions.
- Keep unit a safe distance away from buildings, balconies, or overhangs when in use.
- Do not use on or near combustible surfaces or structures such as wood decks, dry leaves or grass, mulch, vinyl or wood siding, etc.
- Only use this unit on a level, non-combustible surface.
- Keep away from all combustible materials including gasoline and other flammable liquids and vapors.
- Never use accelerants such as, but not limited to, gasoline, alcohol, paint thinners, kerosene, as this may cause serious injury or product damage.
- Do not overfill this unit or use it to burn leaves or trash.
- This unit becomes very hot when in use. Ensure the unit is completely cool before cleaning or moving.
- Never leave unit unattended while hot or in use.
- Extinguish the fire properly before leaving the unit unattended. If necessary, use a fire extinguisher or sand to smother the fire. NEVER use water to extinguish hot fires or embers as doing so may cause serious injury and/or permanently damage the product.
- Ashes can remain hot for a long time after fire is extinguished. Dispose of cold ashes properly.
- Ensure the unit is completely cool before covering, failure to do so will damage the cover and the unit.
- DO NOT USE CHEMICAL-BASED CLEANERS as this may damage the product and/or ignite a flame during the next use.
- Contact local authorities regarding possible burn restrictions before using this product.

**Any modification to the product or failure to follow recommended care will void the product warranty.**

*If you experience issues with assembly or the product was damaged during transit, please contact our customer service team through one of the methods mentioned at the top of page 1. Please have the item number and order information ready to expedite response time.*

## WARNING:

**Manufacturer and seller expressly disclaim any and all liability from personal injury, property damage or loss, whether direct or indirect, or incidental, resulting from the incorrect attachment, improper use, inadequate maintenance, or neglect of this product.**