

# DUAL SWIVEL CAMPFIRE COOKING GRILL KF-DCG

Review all assembly and care information before using this product. Save this manual for future reference.  
**Assemble components on a soft, clean surface to avoid damaging the finish.**

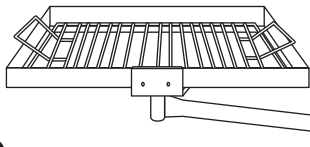





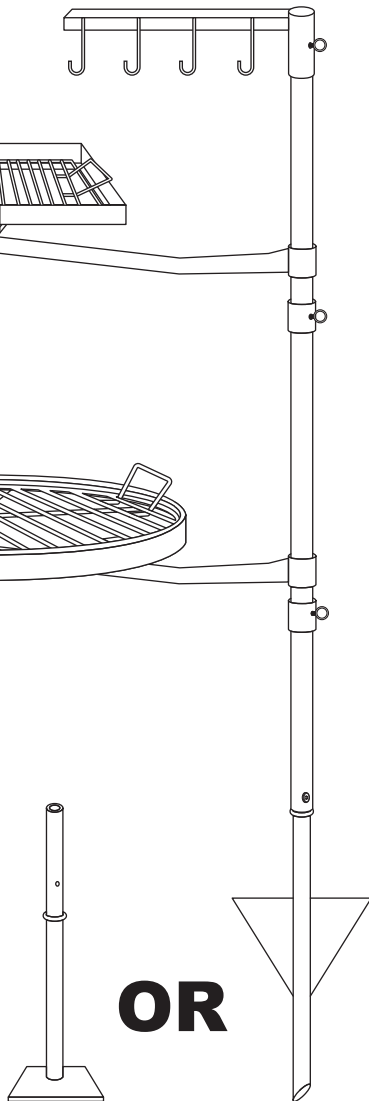
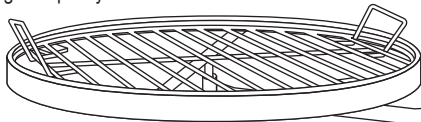



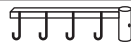

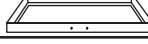
**12**  
 pounds  
 5.4 kg  
 Rectangular Grate  
 Weight Capacity



**20**  
 pounds  
 9.1 kg  
 Round Grate  
 Weight Capacity

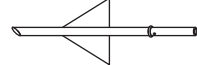
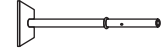

Inspect packaging to ensure all parts are accounted for before disposing of packing materials.

No.	PARTS		QTY.
A		Top Bar with Hooks	1
B		Eye Bolt	3
C		Rectangular Cooking Grate	1
D		Rectangular Grate Frame	1
E		Bracket	1
F		Arm	2
G		Round Cooking Grate	1
H		Round Grate Frame	1
I		Height Adjustment Tube	2
J		Main Tube	1
K		Step-In Base	1
L		Square Base	1
T1		1/4" x 5/8" Bolt	2
T2		1/4" x 1-3/8" Bolt	1
U		Washer	3
V		Nut	3

**OR**

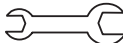
INCLUDED TOOLS	
	Hex Key
	Spanner

**! WARNING !**

**CHOKING HAZARD** — This item contains small parts that can be swallowed. Keep children and pets away during assembly.

**! WARNING:**

Manufacturer and seller expressly disclaim any and all liability from personal injury, property damage or loss, whether direct or indirect, or incidental, resulting from the incorrect attachment, improper use, inadequate maintenance, or neglect of this product.

# ASSEMBLY

**! IMPORTANT:** When assembling and using this system, prevent leaning or tipping by ensuring the base and main tube remain straight.

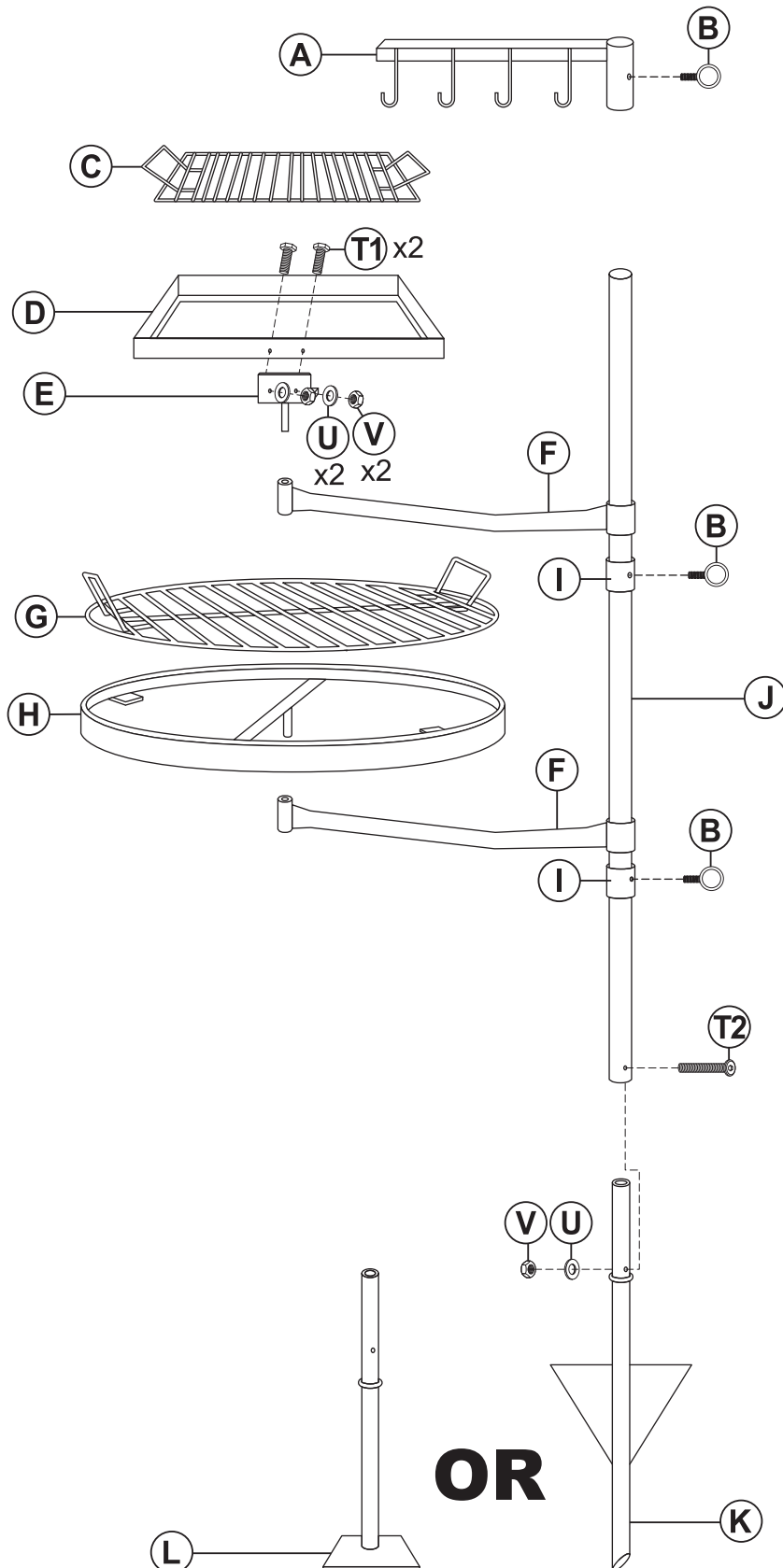

1. Select and install the base.

## Step-In Base (K) -- temporary installation

Choose a location with soil that is firm enough to support the unit while in use. Do not install into loose soil as it may result in the unit tipping over.

Ensuring the base remains straight, hold the pole and push the step-in stake into the ground while simultaneously stepping on it until it is flush with the ground. If you encounter resistance during installation, do not force the base into the ground; check for obstructions such as stones or tree roots.

## Square Base (L) -- permanent installation

Install this base into wet concrete (not included). Ensure the base remains straight as the concrete sets.

2. Securely fasten Main Tube (J) to the base using one 1/4" x 1-3/8" (T2), Washer (U), and Nut (V).
3. Slide one Height Adjustment Tube (I) about two-thirds down the main tube and loosely secure using one Eye Bolt (B). Slide one Arm (F) over the main tube. Then, install the remaining adjustment tube and arm a few inches below the top of the main tube.
4. Install Top Bar with Hooks (A) onto the main tube using one Eye Bolt (B).
5. Secure Bracket (E) to Rectangular Grate Frame (D) using two 1/4" x 5/8" Bolts (T1), Washers (U), and Nuts (V).
6. Install the rectangular grate frame on the top arm and place Rectangular Cooking Grate (C) inside the frame.
7. Install Round Grate Frame (H) on the bottom arm and place Round Cooking Grate (G) inside the frame.

**OR**

# CARE & MAINTENANCE

**SAFE USE:** Follow all safety statements and warnings.

Do not install this unit where it could easily tip over during use.

Do not exceed the weight capacities and ensure weight is evenly distributed; improper weight distribution may cause the unit to lean, tip over, and/or cause the adjustment tubes to slip and fall.

The cooking grate will become extremely hot while in use. Always use heat-resistant gloves and long-handle utensils when cooking with this product. Ensure the unit is completely cool before cleaning or moving.

Turn the arms slowly to avoid food rolling off the cooking grates.

Assistance may be required to hold the cooking grate steady while flipping and moving food on the cooking grate.

This product is only to be used by adults with developed comprehension and motor skills.

**CLEANING:** Clean the grilling grates after each use. The grates must be completely cool before cleaning; if you feel heat when your hand is close to the metal, it is too hot to clean. Use warm water, mild detergent, and a medium-bristle scrub brush to clean the grate. Dry with a soft, clean towel.

**EXPOSURE & MAINTENANCE:** Long-term exposure to high-intensity heat can cause the high-temperature paint to flake or burn off the steel. If the steel is exposed to moisture, it will rust. Limit exposure to precipitation and high moisture. Ensure the unit is completely cool and cleaned before storing; if you feel heat when your hand is close to the metal, the unit is too hot to move and store. Store in a cool, dry, indoor when not in use. Manufacturer is not liable for damage resulting from general use, misuse, and/or environmental conditions. Immediately discard rusted cooking grates.

**WARNING: THE ONE-YEAR WARRANTY DOES NOT COVER DAMAGES OR DEFECTS CAUSED BY THE APPLICATION OF CHEMICAL TREATMENTS, PROTECTIVE COATINGS, TOUCH-UP PAINT, OR CLEANING PRODUCTS.**

## SAFETY STATEMENTS & WARNINGS

- For outdoor use only. Never use this product in an enclosed area.
- Only use on hard, compact surfaces such as packed dirt or between rocks.
- Always follow local laws and regulations when using fire pits. Exercise the same care and precautions as you would with an open fire.
- Always supervise children and pets within the proximity of this product, whether it is in use or not in use.
- Never use any fire pit during dry or windy conditions.
- Keep this unit a safe distance away from buildings, balconies, or overhangs when in use.
- Do not use on or near combustible surfaces or structures such as wood decks, dry leaves or grass, mulch, vinyl or wood siding, etc.
- Keep away from all combustible materials including gasoline and other flammable liquids and vapors.
- Never use accelerants such as, but not limited to, gasoline, alcohol, paint thinners, kerosene, as this may cause serious injury or product damage.
- Never leave unit unattended while hot or in use.
- Extinguish the fire properly before leaving the unit unattended. If necessary, use a fire extinguisher or sand to smother the fire. NEVER use water to extinguish hot fires or embers as doing so may cause serious injury and/or permanently damage the product.
- DO NOT USE CHEMICAL-BASED CLEANERS as this may damage the product and/or ignite a flame during the next use.
- Contact the local authorities regarding possible burn restrictions before using this product.

**Any modification to the product or failure to follow recommended care will void the product warranty.**

*If you experience issues with assembly or the product was damaged during transit, please contact our customer service team through one of the methods mentioned at the top of page 1.*

*Please have the item number and order information ready to expedite response time.*

### **WARNING:**

**Manufacturer and seller expressly disclaim any and all liability from personal injury, property damage or loss, whether direct or indirect, or incidental, resulting from the incorrect attachment, improper use, inadequate maintenance, or neglect of this product.**