

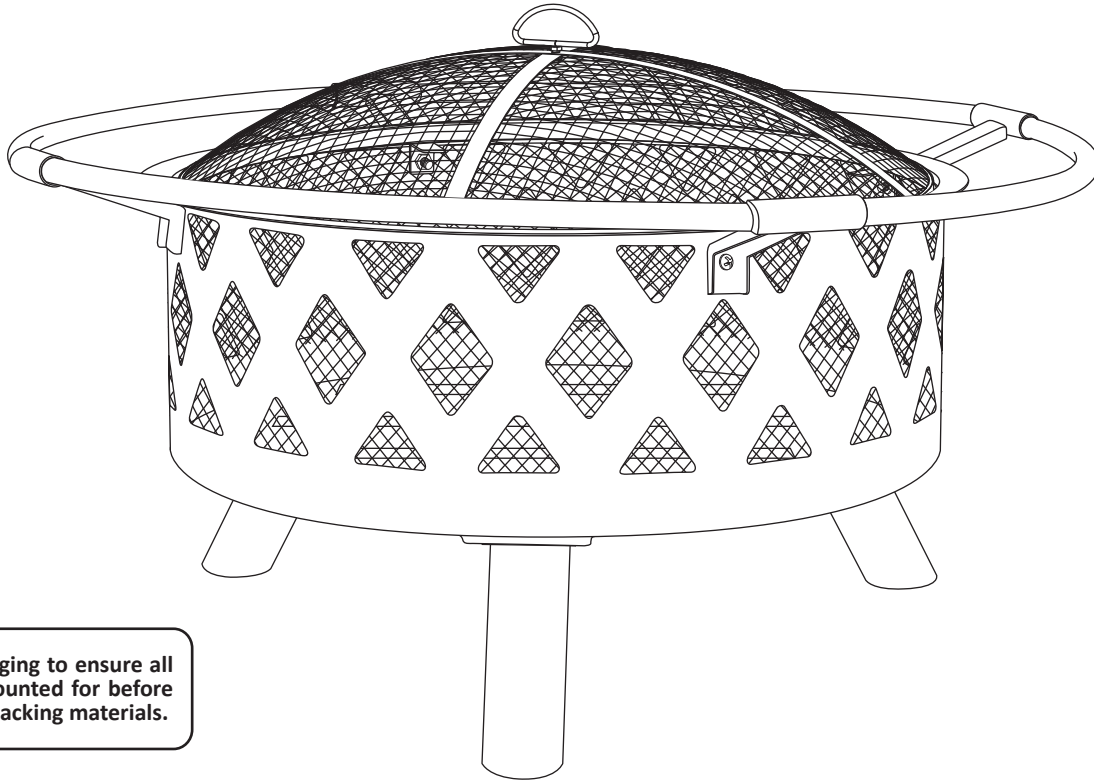













SMALL CROSSWEAVE FIRE BOWL FIRE PIT





Review all assembly and care information before using this product. Save this manual for future reference.
Assemble components on a soft, clean surface to avoid damaging the finish.



 Inspect packaging to ensure all parts are accounted for before disposing of packing materials.

No.	PARTS		QTY.
A		Fire Bowl	1
B		Leg	3
C		Safety Ring	4
D		Bracket	4
E		Spark Screen Handle	1
F		Spark Screen	1
H		Poker/Screen Lifter	1
I		Cover	1

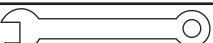
No.	HARDWARE		QTY.
1		M6x10mm Bolt	6
2		M6x20mm Bolt	4
3		Washer	5
4		Nut	5

TOOLS REQUIRED (not included)		
		Phillips Screwdriver
		10mm Wrench

⚠ WARNING ⚠
CHOKING HAZARD — This item contains small parts that can be swallowed. Keep children and pets away during assembly.

⚠ WARNING:

Manufacturer and seller expressly disclaim any and all liability from personal injury, property damage or loss, whether direct or indirect, or incidental, resulting from the incorrect attachment, improper use, inadequate maintenance, or neglect of this product.

ASSEMBLY

Review all steps and understand assembly before beginning.
Do not fully tighten hardware until instructed to do so.

STEP 1 IMPORTANT: The hole in the top corner of the leg plate is a result of the manufacturing process; this hole is not intended to align with the mounting holes in the bracket.

- A: 1
- B: 3
- 1: 6

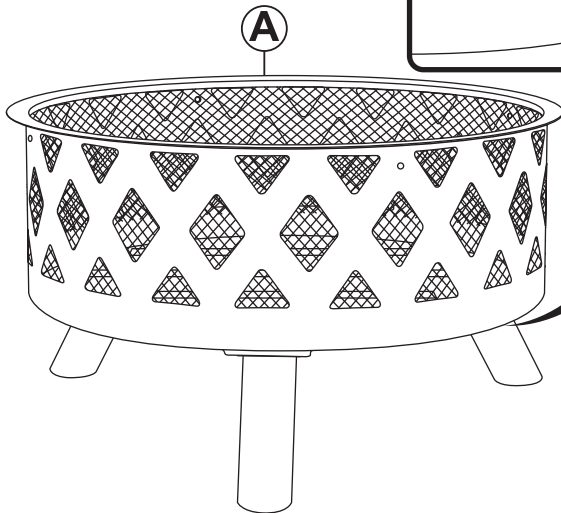
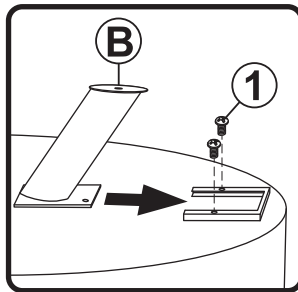

Slide three Legs (B) into the brackets on the bottom of Fire Bowl (A) and tightly secure using six M6x10mm Bolts (1).

NOTE: The pressure from tightening the bolts onto the edges of the leg plate will secure the legs. The hole in the top corner of the leg plate is for powder-coating during manufacturing, do not attempt to align with the bracket holes.

STEP 2

- C: 4
- D: 4
- 2: 4
- 3: 4
- 4: 4

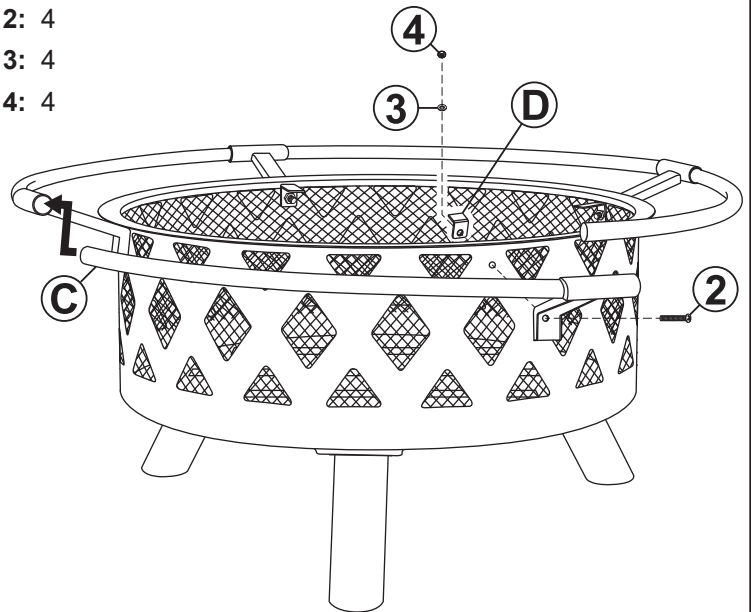

Align one Safety Ring (C) and loosely secure using one M6x20mm Bolt (2), Bracket (D), Washer (3), and Nut (4). Repeat until all safety rings are loosely secured.

Ensuring the brackets are upright, and the ring is straight, tighten all hardware.

STEP 3

- E: 1
- F: 1
- 3: 1
- 4: 1

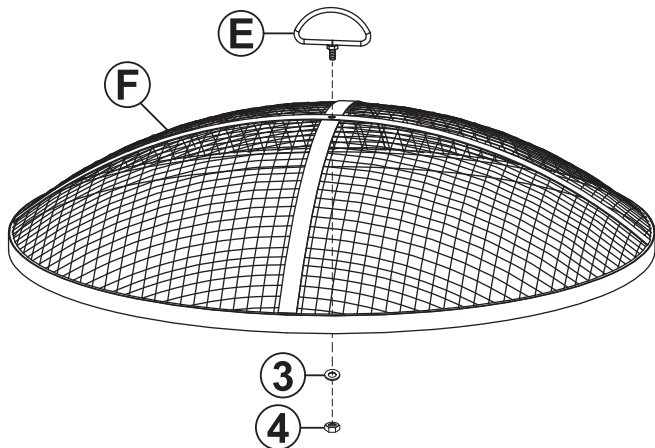

Firmly secure Spark Screen Handle (E) to Spark Screen (F) using one Washer (3) and one Nut (4).

STEP 4

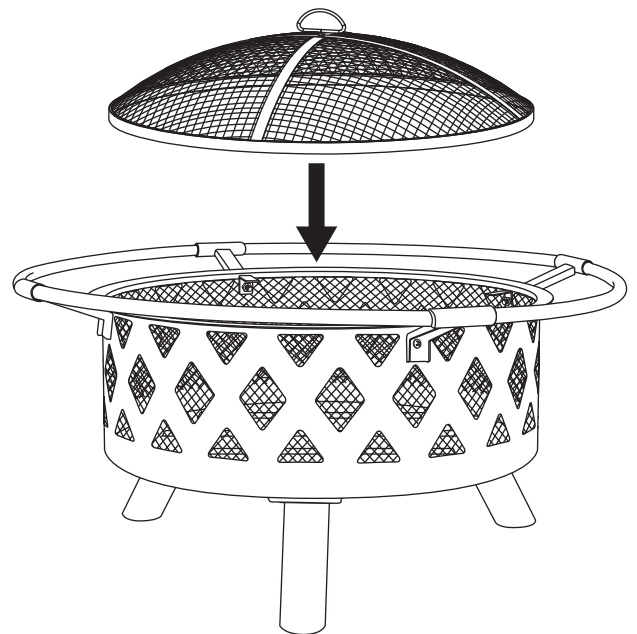

Place the spark screen on the assembled unit.

CARE & MAINTENANCE

SAFE USE: Only use fire pits on a flat, non-combustible surface such as concrete, rock, or stone. Do not use this fire pit on a wood deck or any other combustible surfaces like dry grass, leaves, mulch, etc. Never use in an area with an overhead structure or near any unprotected combustible constructions like vinyl or wood siding. Avoid using near or under overhanging trees and shrubs.

The fire pit will become extremely hot while in use. Always use the poker/lifting tool and heat-resistant gloves when maintaining a fire.

NO ACCELERANTS, NO PLASTICS: Never use an accelerant, i.e. gasoline or kerosene, to start a fire; doing so is dangerous and can damage your fire pit.

Never use any plastic materials in or near a fire pit. The emissions from burning plastic are toxic. Additionally, plastic residue is very difficult to remove.

EXTINGUISH: Let fire die down gradually and go out on its own. DO NOT use water to put out a fire as the sudden drop in temperature may cause serious injury and/or damage the metal.

EXPOSURE & MAINTENANCE: Long-term exposure to high-intensity heat can cause the mesh screens to warp and the high-temperature paint to flake or burn off the steel. If the steel is exposed to moisture, it will rust. As with any outdoor steel product, periodic maintenance is required to maintain integrity and appearance. Remove rust and refinish with a suitable high-temperature paint; carefully follow the paint manufacturer instructions and ensure the paint is completely dry before using the unit again.

CLEANING: Remove ashes and debris before every use. Ensure the fire pit and ashes are completely cool before cleaning. Ashes can remain hot long after a fire dies down. If you feel heat when your hand is close to the metal or the ashes, the unit is too hot to clean.

COVER AND STORE: Ensure the unit is completely cool before covering. Always clean the unit before covering it. Do not allow the fire pit to be exposed to water. Store this unit in a dry location to protect it from environmental elements. The manufacturer is not liable for damage resulting from general use and/or environmental conditions.

WARNING: THE ONE-YEAR WARRANTY DOES NOT COVER DAMAGES OR DEFECTS CAUSED BY THE APPLICATION OF CHEMICAL TREATMENTS, PROTECTIVE COATINGS, TOUCH-UP PAINT, OR CLEANING PRODUCTS.

SAFETY STATEMENTS & WARNINGS

- For outdoor use only. Never use this product in an enclosed area.
- Always follow local laws and regulations when using wood-burning fire pits.
- Exercise the same care and precautions as you would with an open fire.
- Always supervise children and pets when they are in proximity of this product, whether it is in use or not in use.
- Never use any fire pit during dry or windy conditions.
- Keep unit a safe distance away from buildings, balconies, or overhangs when in use.
- Keep away from all combustible materials including gasoline and other flammable liquids and vapors.
- Never use accelerants such as, but not limited to, gasoline, alcohol, paint thinners, kerosene, as this may cause serious injury or product damage.
- Do not overfill or use this unit or use it to burn leaves or trash.
- This unit becomes very hot when in use. Use the poker to lift the spark screen. Ensure the unit is completely cool before cleaning or moving.
- Never leave unit unattended while hot or in use.
- Extinguish the fire properly before leaving it unattended. If necessary, use a fire extinguisher or sand to smother the fire. NEVER use water to extinguish hot fires or embers as doing so may cause serious injury and/or permanently damage the product.
- Ashes can remain hot for a long time after fire is extinguished. Dispose of cold ashes properly.
- Ensure the unit is completely cool before covering, failure to do so will damage the cover and the unit.
- DO NOT USE CHEMICAL-BASED CLEANERS as this may damage the product and/or ignite a flame during the next use.

Contact the local authorities regarding possible burn restrictions before using this product.

Any modification to the product or failure to follow recommended care will void the product warranty.

If you experience issues with assembly or the product was damaged during transit, please contact our customer service team through one of the methods mentioned at the top of page 1. Please have the item number and order information ready to expedite response time.

WARNING:

Manufacturer and seller expressly disclaim any and all liability from personal injury, property damage or loss, whether direct or indirect, or incidental, resulting from the incorrect attachment, improper use, inadequate maintenance, or neglect of this product.